

# Brunswick 40 (480x480)

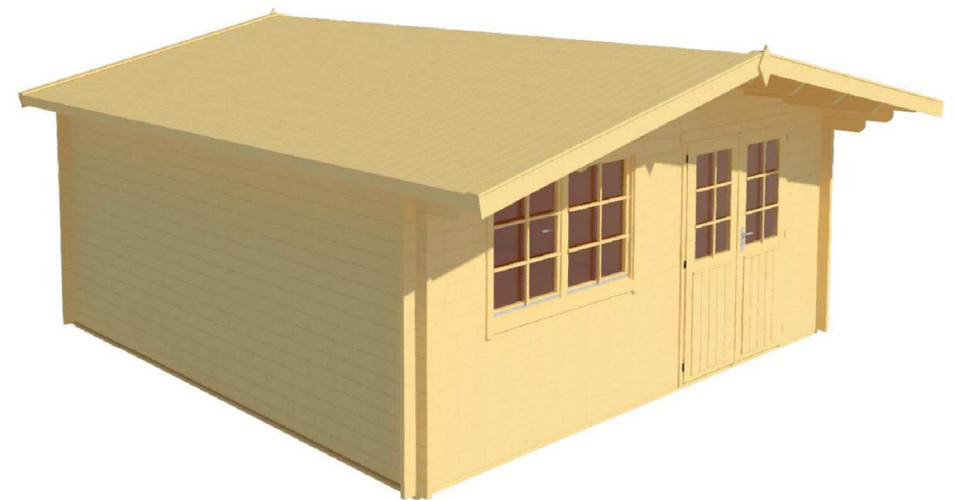

# Brunswick 40 (480x480)

Foundation

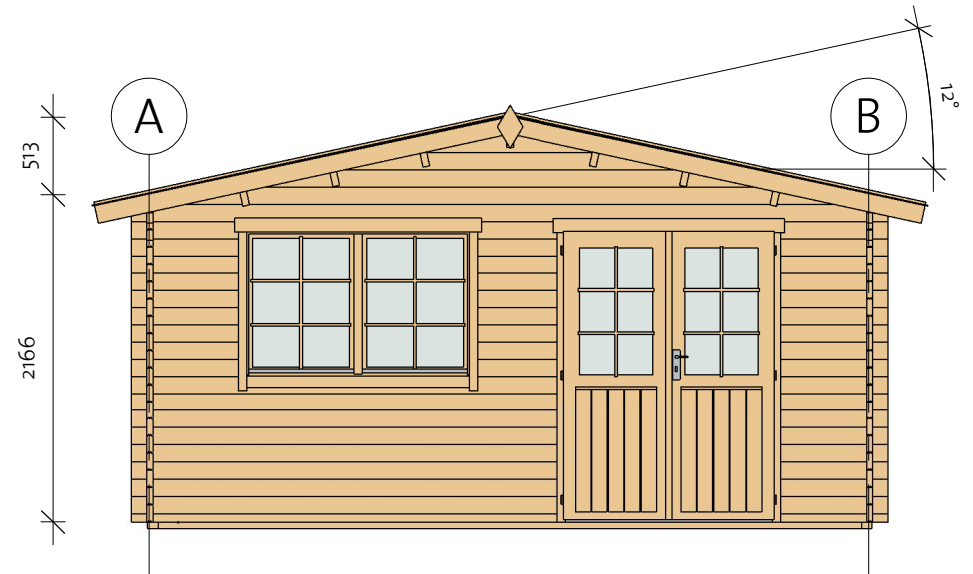
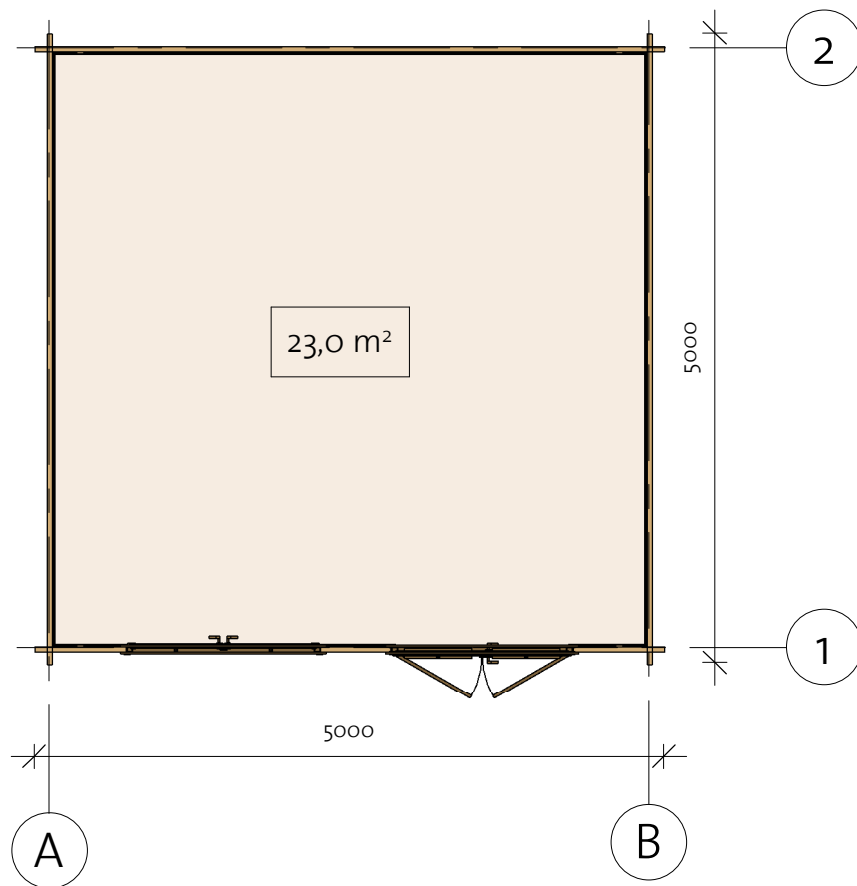
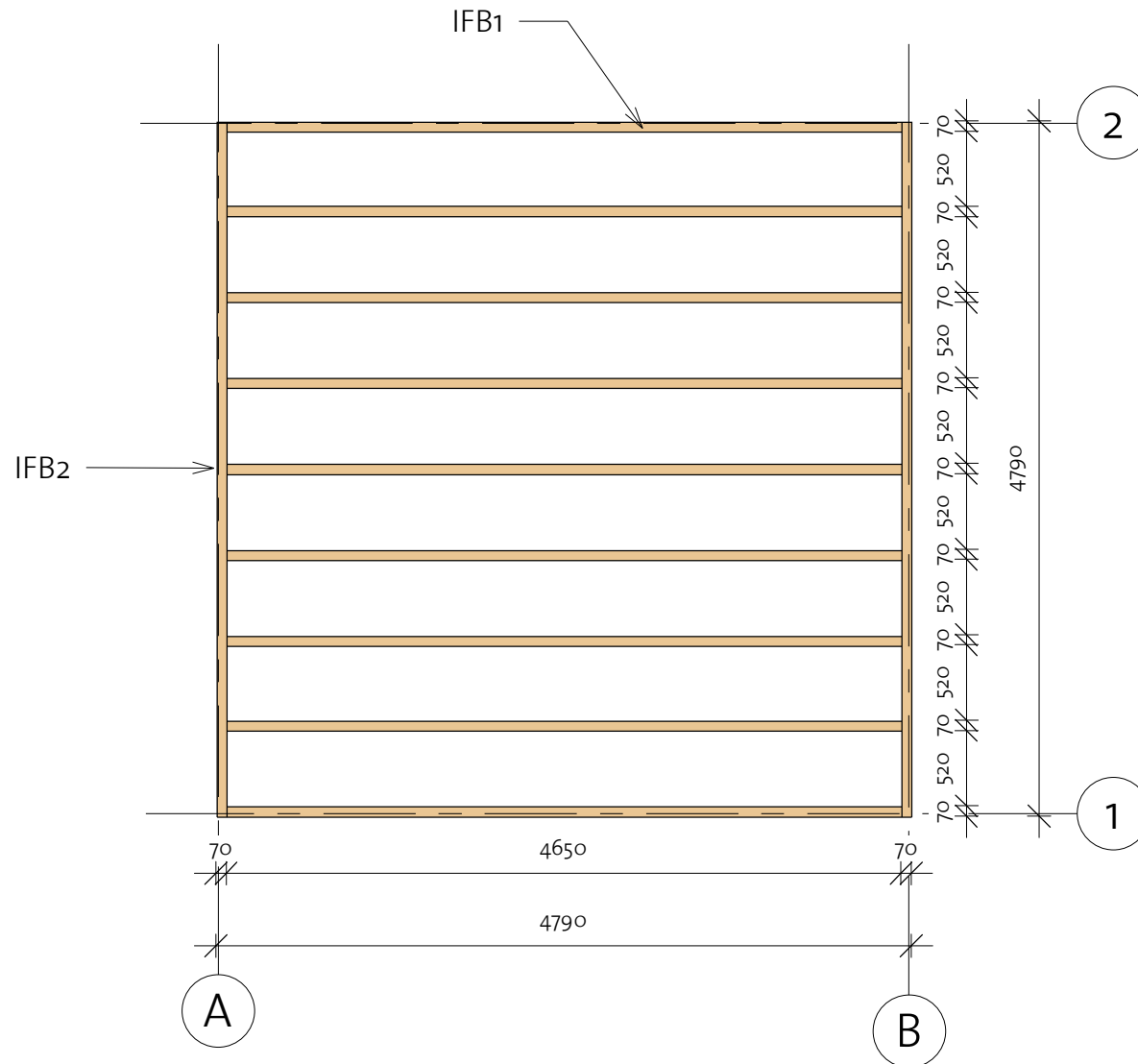

Impregnated foundation beams				
Mark	Type	Profile	Count	Length
IFB1	IFB 70x40		9	4650
IFB2	IFB 70x40		2	4790



# Brunswick 40 (480x480)

Floor Plan

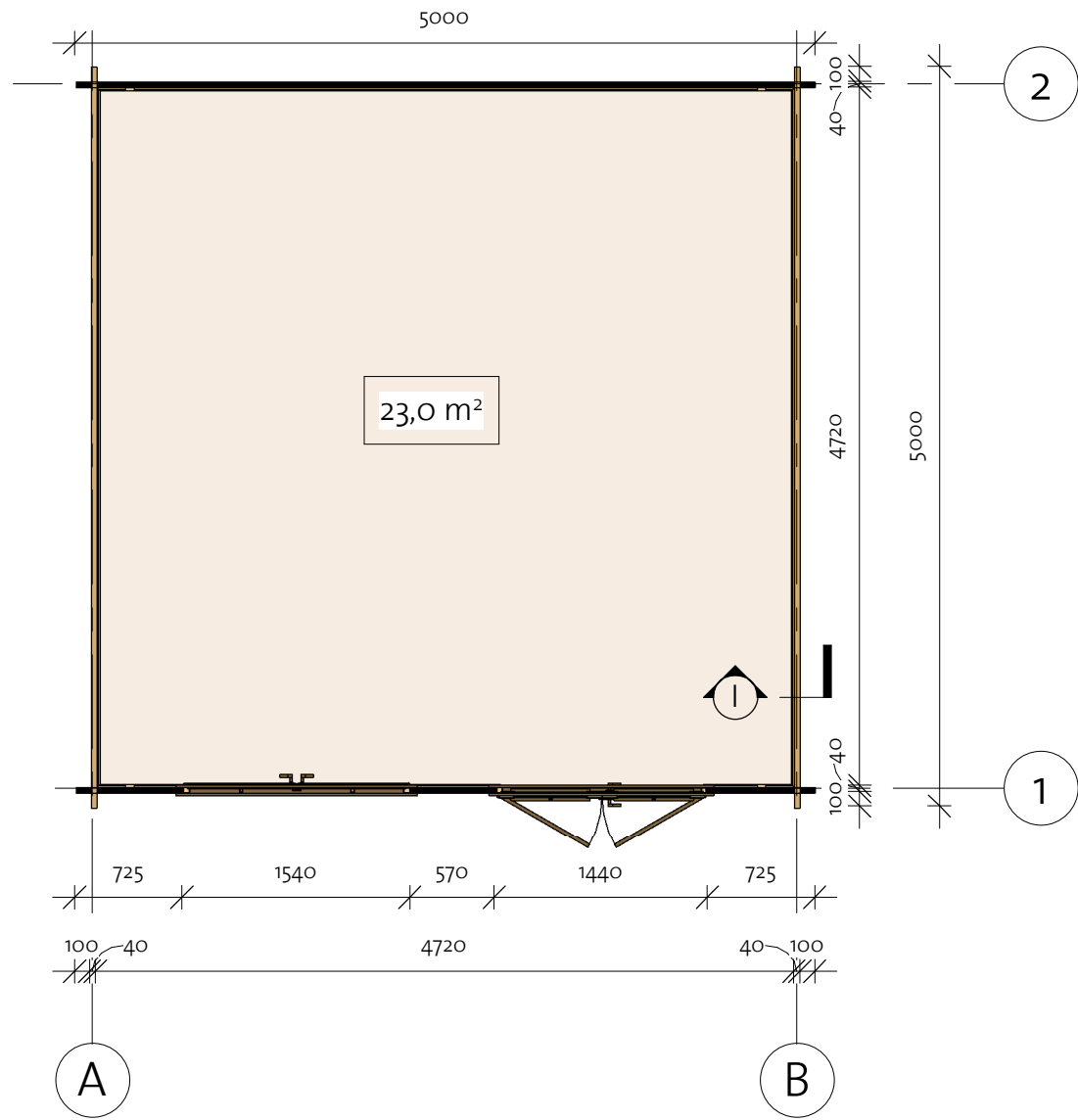
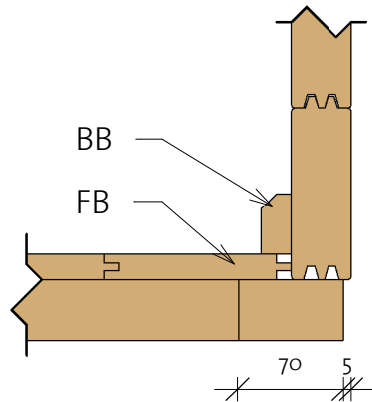
① Baseboard



Floor Schedule

Mark	Type	Profile	Count	Length
FB	FB 17x114		43	4714
BB	BB 20x40		4	4800

# Brunswick 40 (480x480)

Wall 1

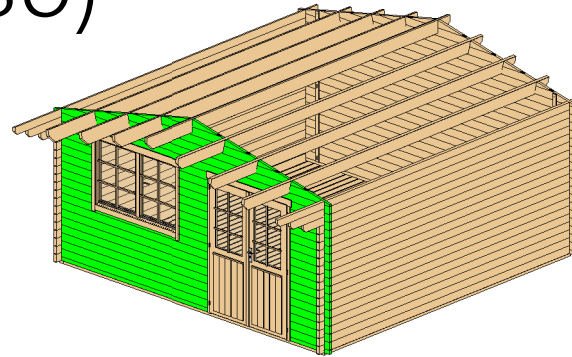



Wall 1			
Mark	Profile	Count	Cut Length

1BL-1	40x57	1	725
1BL-2	40x57	1	2835
1LG-1	40x114	9	570
1LG-2	40x114	26	725
1LG-3*	40x114	1	1050
1LG-4*	40x114	1	2099
1LG-5*	40x114	1	3147
1LG-6*	40x114	1	4196
1LG-7	40x114	8	2835
1LG-8*	40x114	1	5000
1LG-9	40x114	1	5000

\* Gable - delivered premounted

Log Profile Wall 1	
Profile	Profile

40x57	
40x114	

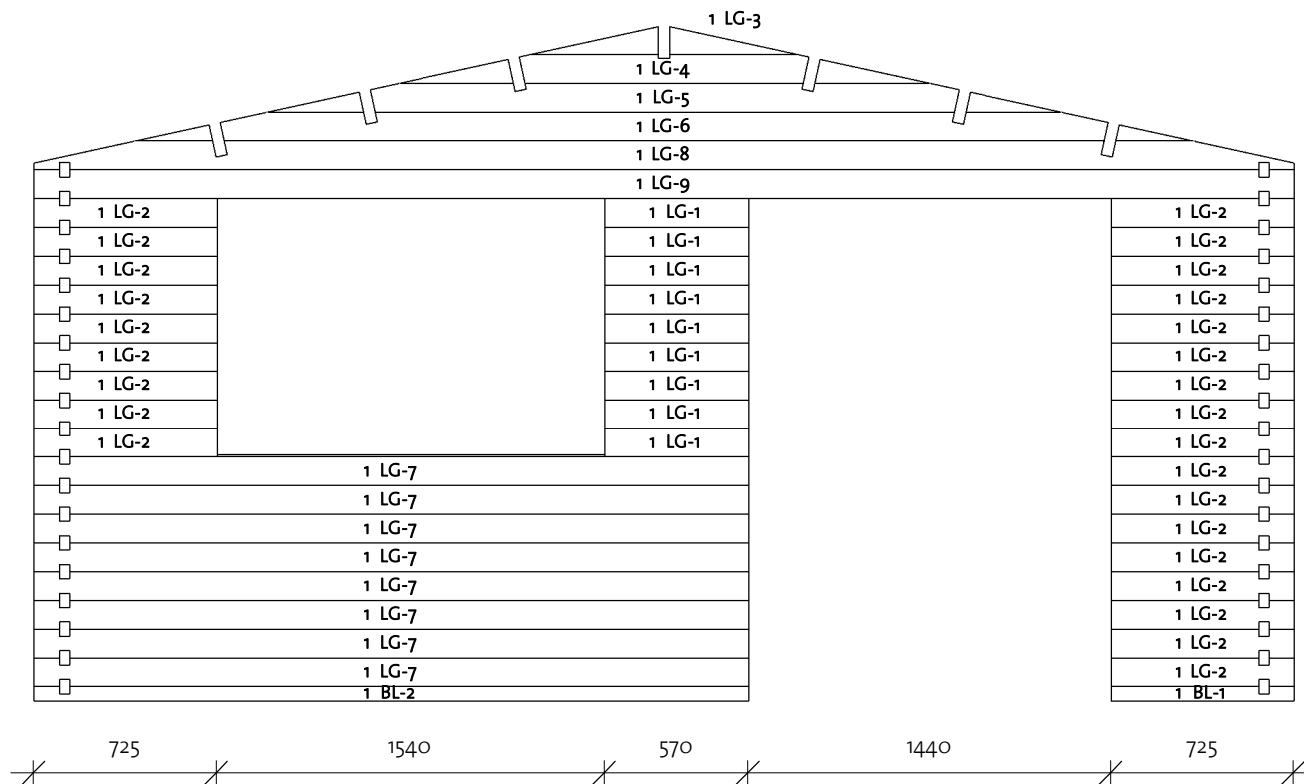

# Brunswick 40 (480x480)

Wall 2

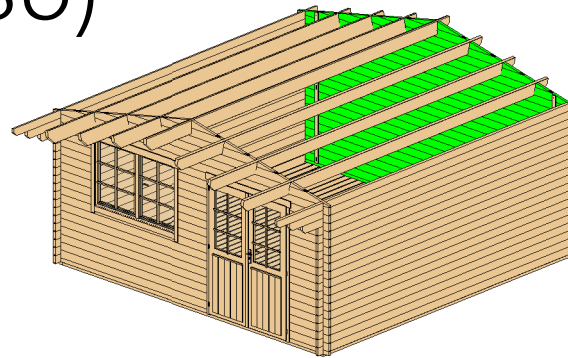

Wall 2			
Mark	Profile	Count	Cut Length

2BL-1	40x57	1	5000
2LG-1*	40x114	1	1050
2LG-2*	40x114	1	2099
2LG-3*	40x114	1	3147
2LG-4*	40x114	1	4196
2LG-5*	40x114	1	5000
2LG-6	40x114	18	5000

\* Gable - delivered premounted

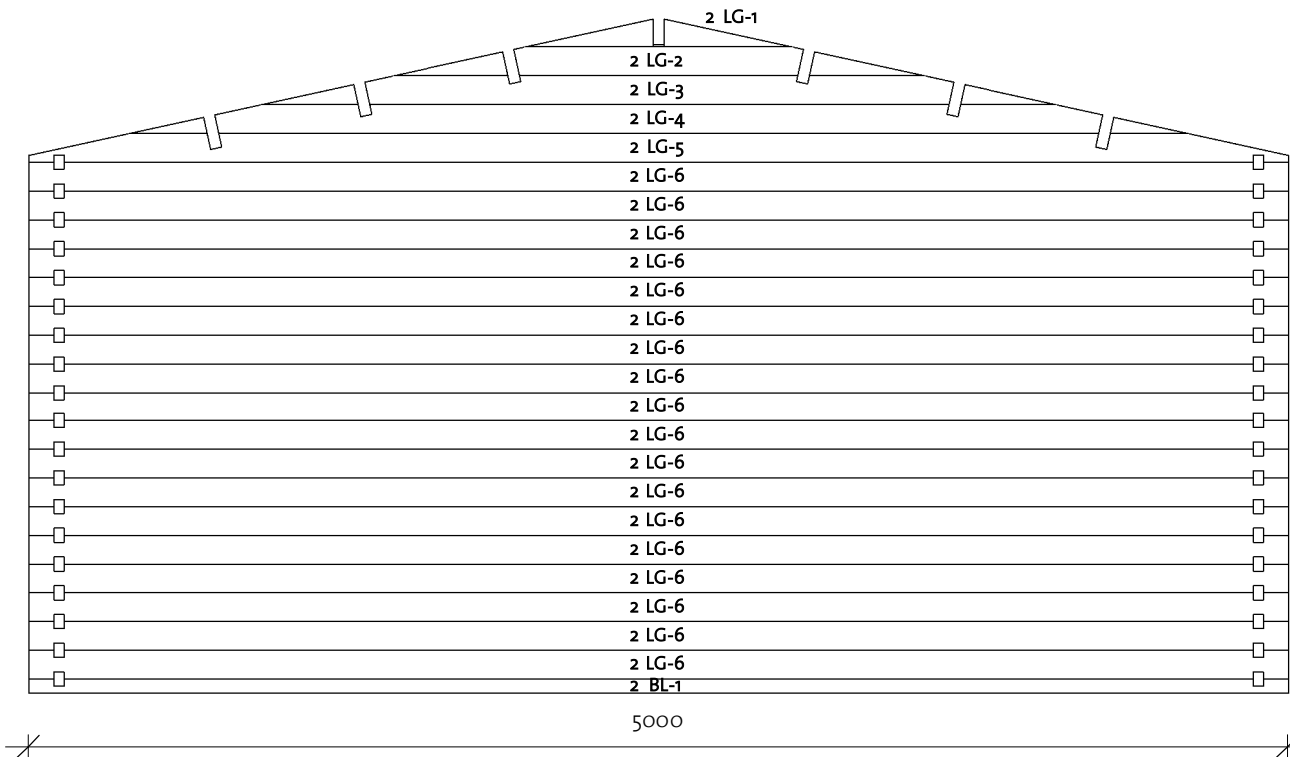

Log Profile Wall 2	
Profile	Profile

40x57	
40x114	

# Brunswick 40 (480x480)

Wall A

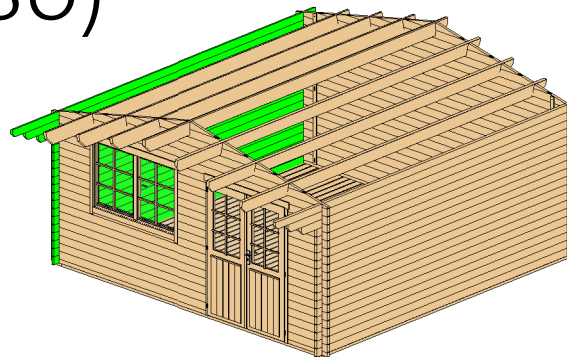

Wall A			
Mark	Profile	Count	Cut Length

ALG-1	40X114	16	5000
ALG-2	40X114	1	5300
ALG-3	40X114	1	5550
ATL-1	40X114	1	5900

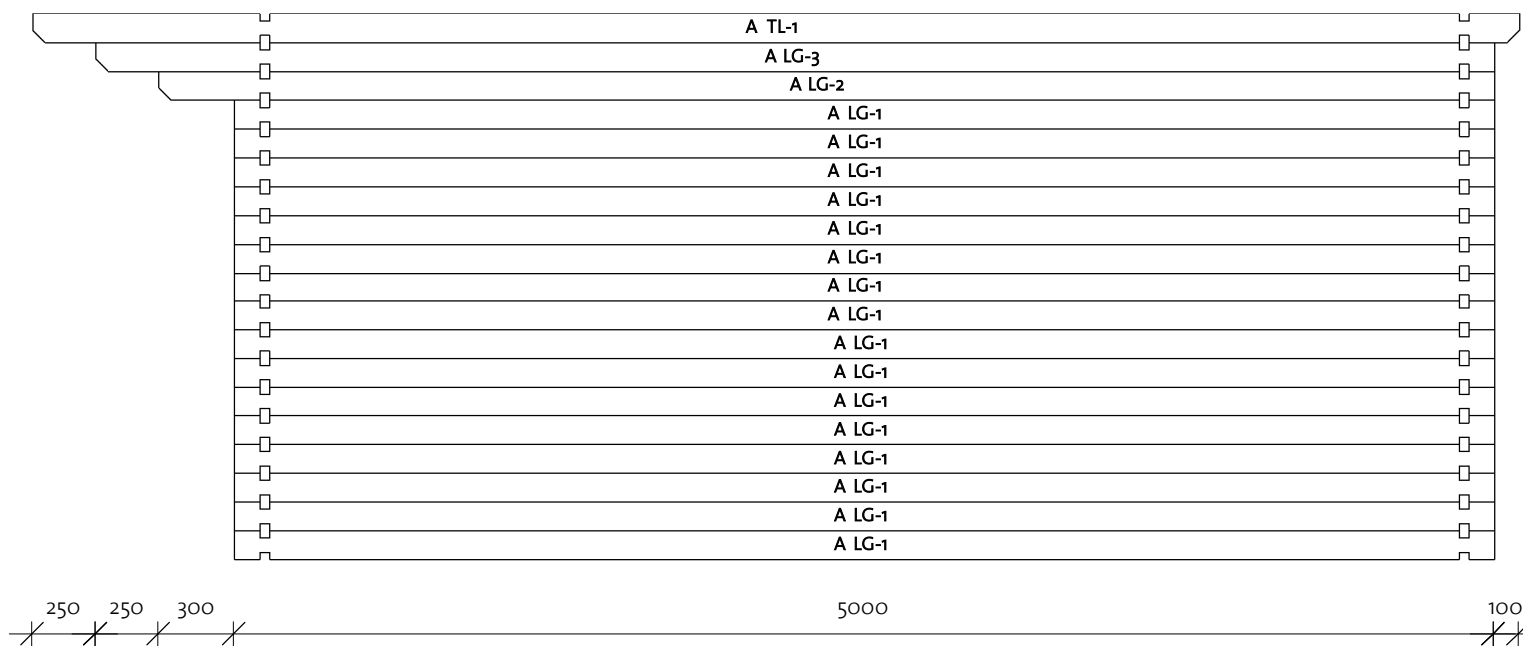

Log Profile Wall A	
Profile	Profile

40X114	
40X114	

# Brunswick 40 (480x480)

Wall B

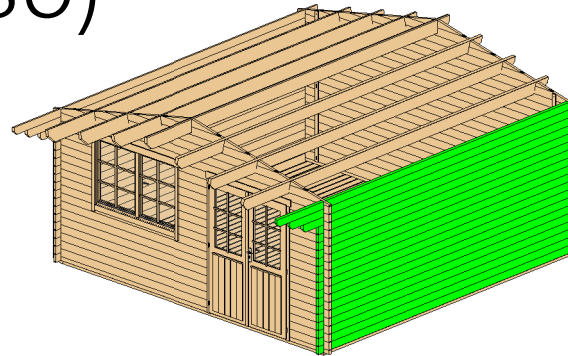

Wall B			
Mark	Profile	Count	Cut Length

BLG-1	40X114	16	5000
BLG-2	40X114	1	5300
BLG-3	40X114	1	5550
BTL-1	40X114	1	5900

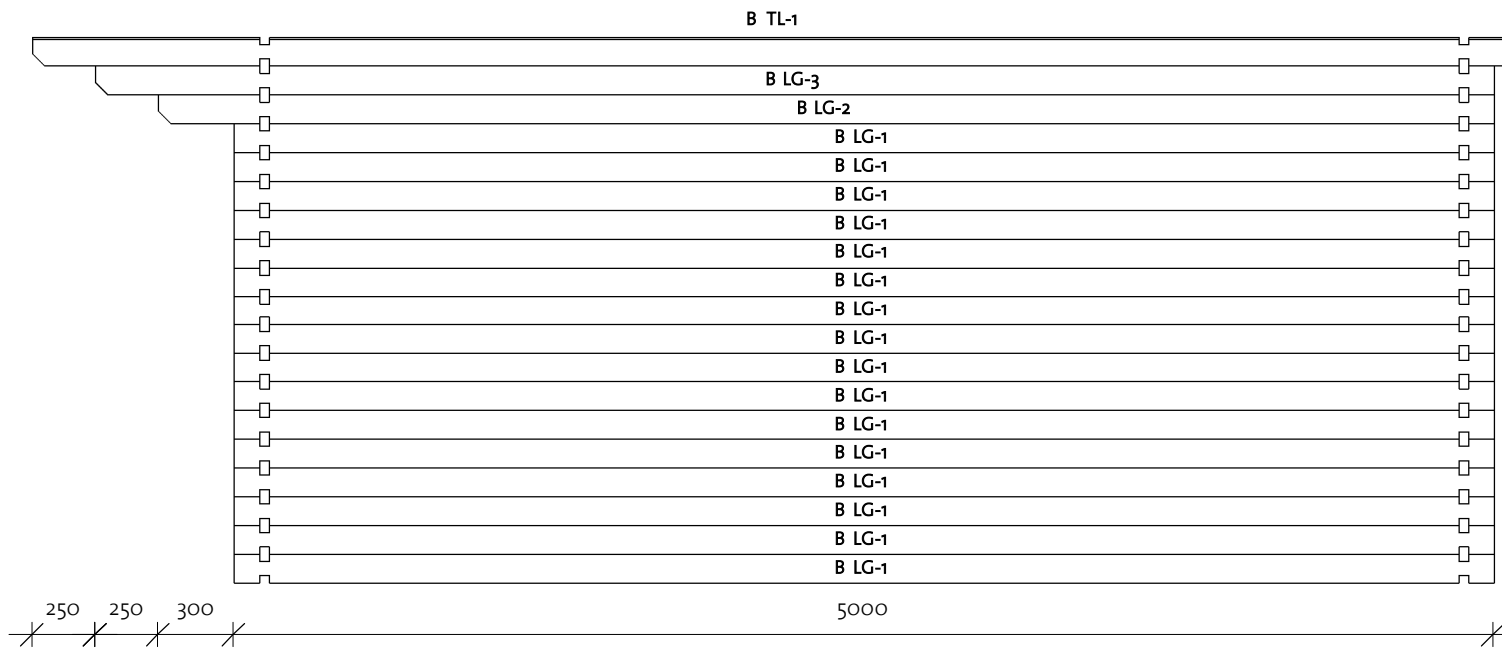





Log Profile Wall B	
Profile	Profile

40X114	
40X114	

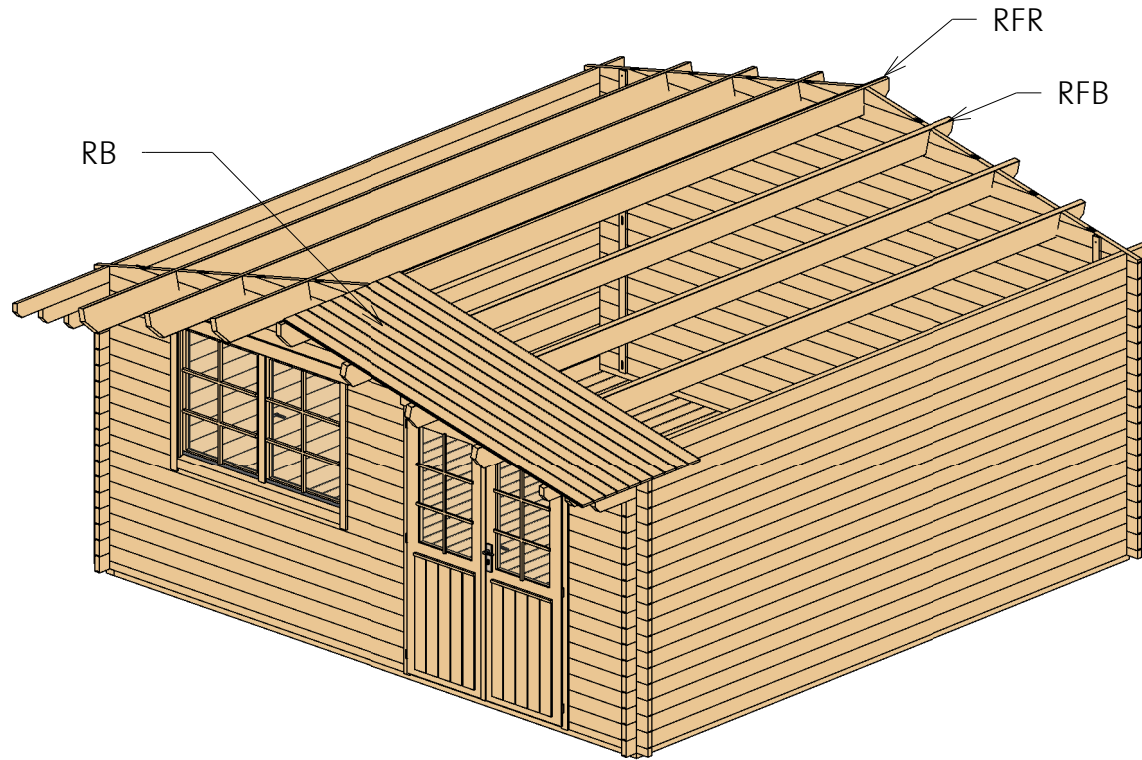
# Brunswick 40 (480x480)

Roof 1



Roof				
Mark	Type	Profile	Count	Length
RFR	Ridge 45x195		1	5900
RFB	Beam 45x195		6	5900
RB	17x114		104	2770



# Brunswick 40 (480x480)

Roof 2

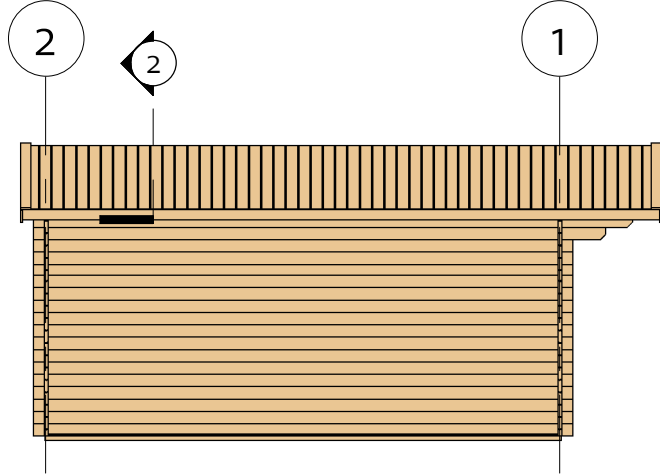

② Facia

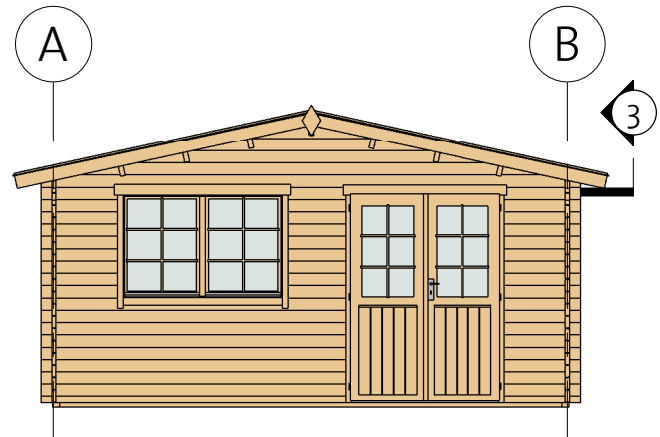
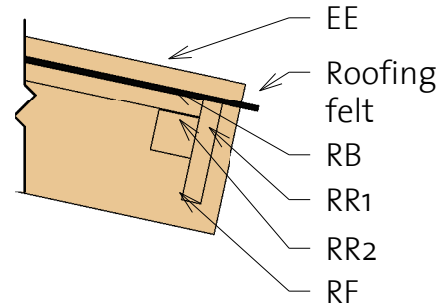

③ Roof Reinforcement

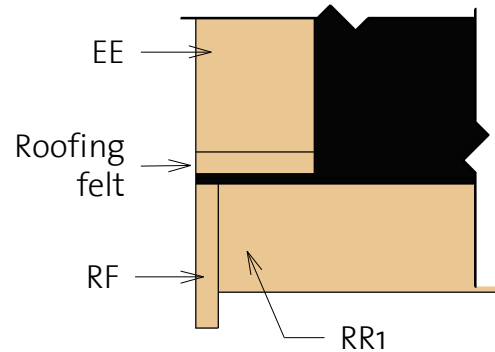

Fascia Schedule

Mark	Type	Profile	Count	Length
EE	Eave Edging 18x95		4	2809
RF	Roof Fascia 18x120		4	2809
RR1	Roof reinforcement 18x95		2	5900
RR2	Roof reinforcement 38x38		2	5900

# Brunswick 40 (480x480)

Extras

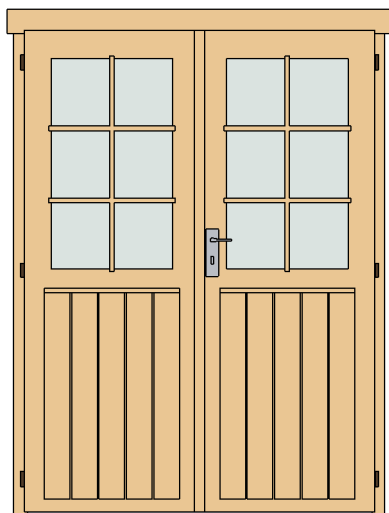

Door Schedule				
Mark	Type	Width	Height	Count
CDD1R	Classic double door 1 right	1425	1955	1
DCB6	Door Crossbar 6	--	--	2

Window Schedule				
Mark	Type	Width	Height	Count
CDW1	Classic double window 1	1530	990	1
WCB6	Windows Crossbar 6	--	--	2

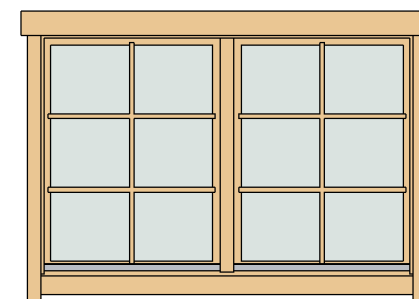

Fasteners & Extras		
Name	Type	Count

Hitblock	300-400 mm	
Bolts	M8 x 70	12
Screws	5,0 x 70	15
Nails	1,4 x 40	50
Screws	6,0 x 140	70
Screws	4,0 x 40	1130



Type	Count	Length
Windboard 18x40	4	2200



Family	Count
Romb	2





# Brunswick 40 (480x480)

## List of all items 1





### Impregnated foundation beams

Mark	Type	Profile	Count	Length
IFB1	IFB 70x40		9	4650
IFB2	IFB 70x40		2	4790



### Floor Schedule

Mark	Type	Profile	Count	Length
FB	FB 17x114		43	4714
BB	BB 20x40		4	4800

### Fascia Schedule

Mark	Type	Profile	Count	Length
EE	Eave Edging 18x95		4	2809
RF	Roof Fascia 18x120		4	2809
RR1	Roof reinforcement 18x95		2	5900
RR2	Roof reinforcement 38x38		2	5900

### Roof

Mark	Type	Profile	Count	Length
RFR	Ridge 45x195		1	5900
RFB	Beam 45x195		6	5900
RB	17x114		104	2770

# Brunswick 40 (480x480)

## List of all items 2

### Wall 1

Mark	Profile	Count	Cut Length
------	---------	-------	------------

1BL-1	40x57	1	725
1BL-2	40x57	1	2835
1LG-1	40x114	9	570
1LG-2	40x114	26	725
1LG-3*	40x114	1	1050
1LG-4*	40x114	1	2099
1LG-5*	40x114	1	3147
1LG-6*	40x114	1	4196
1LG-7	40x114	8	2835
1LG-8*	40x114	1	5000
1LG-9	40x114	1	5000

### Wall A

Mark	Profile	Count	Cut Length
------	---------	-------	------------

ALG-1	40x114	16	5000
ALG-2	40x114	1	5300
ALG-3	40x114	1	5550
ATL-1	40x114	1	5900

### Wall 2

Mark	Profile	Count	Cut Length
------	---------	-------	------------

2BL-1	40x57	1	5000
2LG-1*	40x114	1	1050
2LG-2*	40x114	1	2099
2LG-3*	40x114	1	3147
2LG-4*	40x114	1	4196
2LG-5*	40x114	1	5000
2LG-6	40x114	18	5000

\* Gable - delivered premounted



### Wall B

Mark	Profile	Count	Cut Length
------	---------	-------	------------

BLG-1	40x114	16	5000
BLG-2	40x114	1	5300
BLG-3	40x114	1	5550
BTL-1	40x114	1	5900

### Log Profiles

Profile	Profile
---------	---------

40x57	
40x114	

### Log Profiles

Profile	Profile
---------	---------

40x114	
--------	---

# Windboard

① Windboard Assembly 1



② Windboard Assembly 2

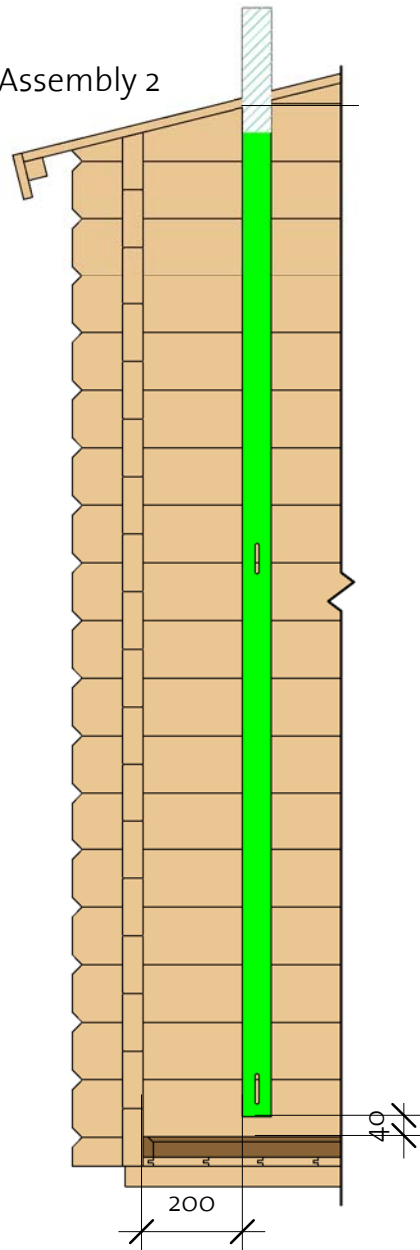

③ Windboard Assembly 3

